

Service Network:

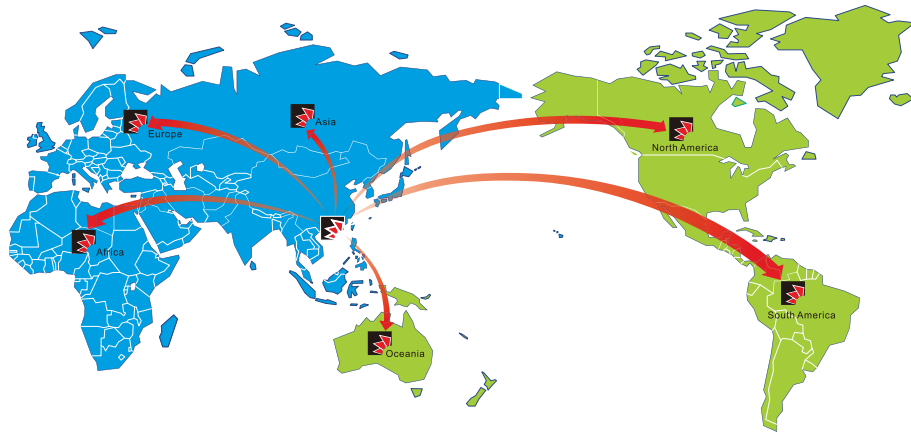

201705EV4.0



P1500 series

High-performance standard
vector control inverter

Powtran technology

Professional manufacturer of frequency inverter based on the
motor design and manufacture.

Contact

Dalian Powtran Technology Co.Ltd.Shenzhen Branch.
Address:No.75, Baomin 2nd Road, Xixiang Town,Baoan District, Shenzhen, China(518101)
Tel: 0086-755-29630738
Fax: 0086-755-29666485
Email: info@powtran.com
Website : www.powtran.com

Hotline:0086-0755-29630738



www.powtran.com

Contents

Contents.....	01
Product Overview.....	02
About Powtran.....	03-04
Company Profile.....	03
Honor.....	03
Certificates.....	04
Product Performance.....	05-12
Nameplate Instruction.....	13
Technical Features.....	14
Standard Specification	15-16
Keypad Instruction.....	17
Installation Instruction.....	18
Main Circuit Terminal	19
Optional Parts.....	20
Applications.....	21-22

Product Overview

PI500 series high-performance vector control inverter is based on the company's many years of design, production, sales experience, suitable for all kinds of industrial machinery, fan & water pump drive control and heavy industry such as medium frequency grinding. Products in duct design, hardware configuration, software functions, installation design has greatly improved the customer ease of use and environmental adaptability, function optimization, application is more flexible, more stable performance, greatly improve the product reliability.





Company Introduction

Powtran Technology as a national high-tech enterprise, set up Wuxi, Guangzhou and more than 30 offices with the center of Shenzhen and Dalian cities and established a worldwide network of R & D, production, logistics and service. Composing the advanced technology from Japan Toshiba and Taiwan brand, Powtran provides a series of energy saving and automatic & drive control products. such as frequency inverters(including special power supply), soft starters, AC servo drive system, energy saver, vehicle motor drive system. Powtran products are verified by international authoritative organizations and now export to more than 100 countries.

Company History

- 2016 : Won the "2015 ~ 2016 annual inverter innovation award"; as the vice chairman of the China Electrical Equipment Industry Association -inverter branch for three consecutive years , and won the advanced member during 2012-2016
- 2015 : PI500 series of high-performance vector inverter was launched; won the award "the most influential brand in three decades";
- 2014: TÜV factory-examining certification company .The standards that Powtran took part in drafting already implemented.
- 2013: PI9000 series new product has passed the EU CE security certification.
- 2012: Continuous 6 years of holding the "low voltage converter top ten domestic brand"
- 2011: Provincial electric drive engineering research center
- 2010: Ministry of science and technology innovation fund for the project
- 2009: National Top-new technical enterprise
- 2008: "The ten major energy conservation projects"
- 2007: The vice chairman of the association of frequency converter enterprise; PS7000 motor environmental protection energy efficient appliances, PI7900 electromagnetic stirring power be inspected by national authoritative organization
- 2006: Bear "Torch Plan", 863 Plan Projects , PI7000 series inverter passed GB12668 inspection and Provincial scientific and technological achievements appraisal
- 2005: America ABS approve; National authoritative organization verification
- 2004: ISO9001 Quality Certificate

Technical Features

Rotary self learning	Static self learning
the learning must release load, it is suitable for requiring high control precision	it is suitable for motor can't release load occasions, to avoid can't rotate self-learning after installation

Precise motor parameter self learning

- Motor parameters can be comprehensive self-study (rotary self learning) or still learning (motor) with the occasion of the load cannot escape, convenient debugging, simple operation, provide higher control accuracy and response speed.

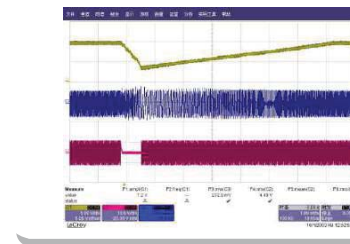

Instantaneous power off don't stop function

- When grid instantaneous drops or outages, inverter can borrow feedback energy and keep running without stop in effective time, especially suitable for the equipments which needs higher continuity, such as textile production line, chemical fiber.

reliable design

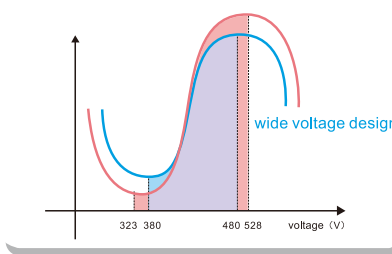

Meet the international standard of wide voltage input range

- Rated voltage: 3phase 380-480v 50Hz/60Hz
- Allow voltage float range: rated voltage $\pm 15\%$.

Technical Features

Superior performance in motor drive



Advanced motor drive technology

- A variety of motor drive technology: no matter asynchronous motor or synchronous motor, it can implement high-performance current vector control. (eg: normal asynchronous motor Y2 series, Frequency conversion motor with encoder or W/O encode, asynchronous servo motor, permanent magnet synchronous motor etc).

Technical Features

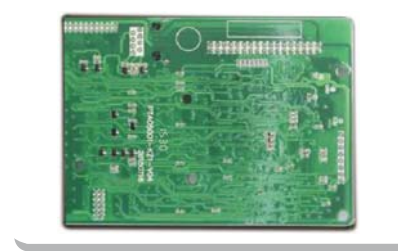

Anti-corrosion paint spraying process

- High protection design, use the import anti-corrosion paint, moisture proof, dustproof, oil proof, corrosion resistance, improve the product reliability, 3D painting, no dead Angle

Technical Features

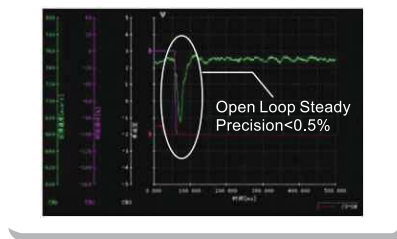

Steady speed precision, wide speed range

- Open-loop steady speed precision < 0.5%
- High steady speed precision, wide adjust speed range
- Steady speed precision: $\pm 0.5\%$ (open-loop vector control) $\pm 0.02\%$ (close-loop vector control)
- Adjust speed range: 1:100 (open-loop vector control), 1:1000 (close-loop vector control)
- Torque response: < 20ms (open-loop vector control) < 5ms (close-loop vector control)
- Heavy load overload capacity: 110% rate stable operation (110% continuously operation)
 - 150% rate load 1Min
 - 180% rate load 5S.

Technical Features

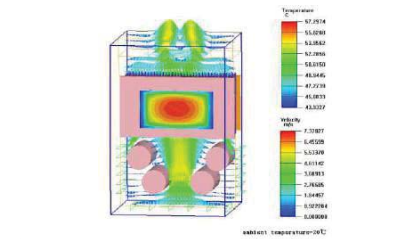

Thermal reliability of the machine

- Adopted high precision thermal simulation platform software, ensuring the thermal reliability of the machine.
- PI500 series inverter, all must go through thermal simulation test. Thermal design is scientific simulation tested, good accuracy, quick efficiency, good stability, especially in the condition of limit test, thermal simulation can replace the actual load test simulation, equivalent to more than a layer of scientific thermal test

Technical Features

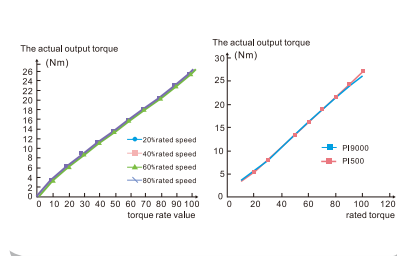

Low speed with high torque small torque ripple

- stable Torque output , high torque with low frequency , to realize the stable load of low speed 0.01 Hz, torque mode and speed mode can be convenient to switch
- In close-loop vector control , linear torque linearity deviation within 3%.

Technical Features



Machine temperature rise test

- The full series of frequency converter had done the rated load temperature rise test and overload temperature rise test, test results accord with thermal design safety margin, ensure safe and stable operation of the converter

Technical Features



EMC Design specifications Improved

- EMC built-in a set of safety capacitance, optional external capacitance group, simple filter, optional filter schaffner can meet C2 international standards
- Using professional grounding pile design, convenient grounding and weaken the electromagnetic interference
- At the scene of the bad to actual application provides EMC filter, common mode rejection, simple filter configuration of a complete set of plan, optimize the environment of EMC electric field devices

Remark: optional filter match CE approve, C2 EMC standard, recommend SCHAFFNER & JIANLI model.



Meet a number of certification standards

- Product is suitable for Euro < Technical coordination and standardization methods > requirements.
EMC directive 2004/108/CE Electromagnetic compatibility directive and LVD directive
2006/95/EC low voltage directive IEC61000-2-2:2002, IEC61000-4-2:2008, IEC61000-4-3:2008; IEC61800-5-1:2007 etc.
- Meet the ROHS directive

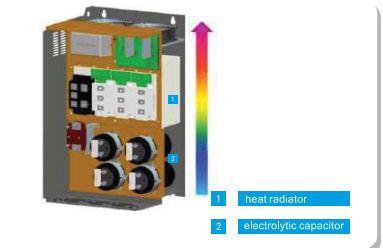

Independent air duct design

- Independent air duct design, the effect of heat dissipating is better, improve the reliability, which can effectively prevent dust into the converter internal to avoid a short-circuit fault etc
- Select longevity's deadly air cooling fan, effectively reduce the temperature rise of frequency converter, inverter reliable and stable operation

Technical Features

The advanced function of changing the class of machines



The compact design to improve the speed of realizing machines minimizing

- Collect the minimum frequency inverter with small and light synchronous motor to speed up the machines minimizing;
- Selecting the long life, big wind cooling fans, new generation IGBT module technology, high efficiency of power, reducing the temperature rise of frequency inverter efficiently, make sure the frequency inverter run steadily.

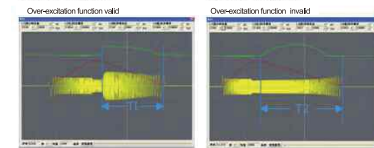

Over-excitation function

- Fast braking and easy operating without any other periphery braking resistor, etc;
- Inhibit the increasing of DC-bus voltage while deceleration, avoid the frequent err, and fast braking, fast stop.



Various kinds of terminals functions, easier for operation

- There are 51 kinds of multi-function terminals DI, 41 kinds of DO, and 16 kinds of AO logical function choice, and meet general purpose frequency inverter normal requirements.
- AI can be used as multi-function terminals DI freely;
- AI1~AI3 can be set 4 respectively polylines and five kinds of curves corresponding relationship separately, support the client to adjust the EXW parameters with the site, expanded AI3 is isolated inputs, support PT100 or ± 10 v input, easily operation;
- Good 5 groups of built-in analog DI and DO function choice, reducing external DI/DO cables, DI5 high-speed pulse input terminal and FM high-speed pulse output terminal support the highest 100kHz pulse.A

Technical Features

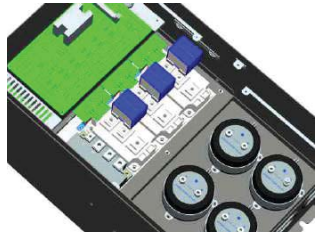

Long life design

- Adopting the first class manufacturers of rectifier bridge and IGBT, higher configure, greater device selection, and monitor all the temperature rise of key components and pcb board;
- Big temperature rise range, longer life;
- Vibration test to make sure the safety of transportation design;
- Internal logistic management(bar code technology, RF technology);
- Sheet Metal design, adopting Cold-rolled steel and galvanized sheet and powder spraying process on the cover

Technical Features

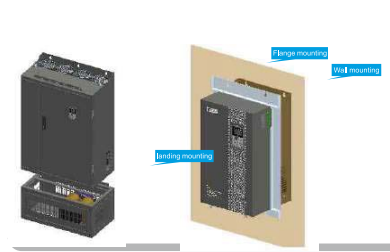

Supporting various kinds of installation ways

- Wall-mounted, flange installation is available for 7.5-110kw (flange mounting needs peripheral accessories);
- Wall-mounted, flange installation, floor installation is available for 132-220kw(flange mounting, floor installation needs peripheral accessories);
- Wall-mounted, floor installation is available for 250-400kw (floor installation needs peripheral accessories);
- Floor-mounted is available for 450-630kw

Great environment friendly function

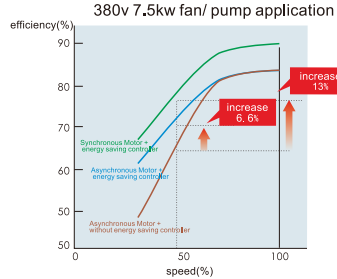

New generation energy saving running

- Adopt the advanced energy control technology
- With the energy control technology to realize the high efficient running of motor;
- Super energy saving while running with synchronous motor;
- Super energy saving while running with synchronous motor, better than asynchronous motor, realize the super energy saving
- ROHS approved, all components are environment friendly, no harm to people, no pollution..

PI500 energy saving for example

Before using controller, the fan of air conditioner 7.5kw*100 sets, price of electricity is RMB 0.7/kwh, 365days of 1 year.

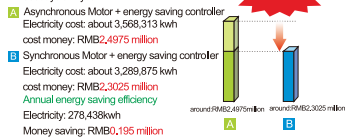

Remark: above example just for reference. real energy saving will be influenced by running condition, load, price of electricity, motor character etc.



1. fans terminals
2. fans fastening screw



Simple maintenance

- Fan can be disassembled, easy to install, clean and replace.

Technical Features

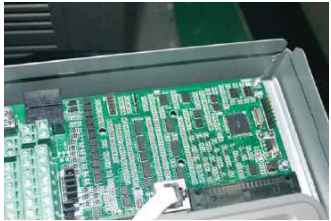

Built in self-adjusting PID function module

- Built in two groups of PID parameters, it is changeable automatically according to the deviation, DI terminal, frequency;
- various given and feedback source, variable and practical type
- PID feedback lost inspection function, it is convenient for user to inspect the fault function;
- Setting factory parameters for special fields to meet the requirements, such as Printing and package, drawing machine, cables etc, these sites are influenced by changeable diameters, simplify the debugging process, and easy to maintain the device.

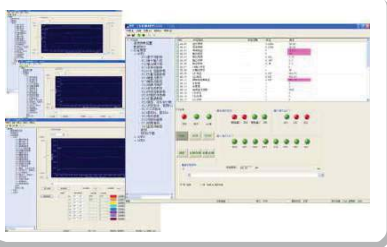

Easy to use PC software

- Easy to use PC monitoring software, enables tracking and fault location, and with oscilloscope function, it's more convenient for clients to program, debug, real time monitoring is very good for analyzing and management.



Communication interface application is very flexible

- Support Modbus RTU, CANopen, Profibus-DP bus Protocol;
- Through a dedicated distribution point of the inverter parameters, to realize a good multi-level load distribution, multi-machine control applications droop.



Improve the production efficiency!
Reduce the enterprise integrated energy costs

Nameplate instruction

Inverter model	→	MODEL: PI500 045G3	→	PI 500 045 G 3	→	Input voltage level
Output rating	→	POWER: 45kW	→		→	1: single phase220V
Input rating	→	INPUT: AC3PH 380V(-15%)-440V(+10%) 50Hz/60Hz	→		→	2: three phase220V
Output specifications	→	OUTPUT: AC3PH 0V-Vin 90A 0-400Hz	→		→	3: three phase380V
Bar code	→		→		→	4: three phase480V
Serial No.	→	ZPB1A8888888	→		→	6: three phase690V
Manufacturer address	→	DALIAN POWTRAN TECHNOLOGY CO.,LTD.	→		→	Function code
			→		→	F: light load
			→		→	G: General load

Rated output power: 045:45KW, 132:132KW

Technical Specification

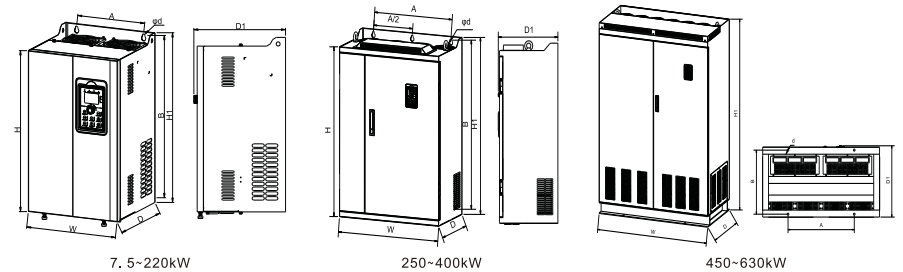

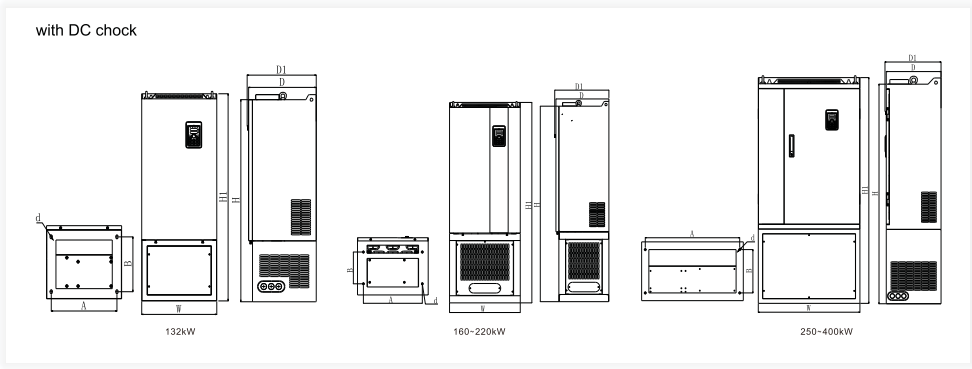

Inverter model	Output power (kW)	Input current (A)	Output current (A)	Dimension(H1xWxD1mm)					Installation (AxB dmm)			N.W (KG)
				H	H1	W	D	D1	A	B	d	
PI500-5R5G1	5.5	50	25	280	300	190	190	198	140	285	6	7.2
PI500-7R5G1	7.5	74	32	330	350	210	190	198	150	335	6	9.5
PI500-011G1	11	84	45	380	400	240	215	223	180	385	7	13
PI500-015G1	15	115	60	500	520	300	275	283	220	500	10	41.2
PI500-018G1	18.5	144	75	550	575	355	320	328	250	555	10	58
PI500-022G1	22	169	90	280	300	190	190	198	140	285	6	7.2
PI500-030G1	30	220	110	330	350	210	190	198	150	335	6	9.5
PI500-037G1	37	276	152	380	400	240	215	223	180	385	7	13
PI500-045G1	45	325	176	500	520	300	275	283	220	500	10	41.2
PI500-055G1	55	380	210	550	575	355	320	328	250	555	10	58
PI500-5R5G2	5.5	28	25	280	300	190	190	198	140	285	6	7.2
PI500-7R5G2	7.5	37.1	32	330	350	210	190	198	150	335	6	9.5
PI500-011G2	11	49.8	45	380	400	240	215	223	180	385	7	13
PI500-015G2	15	65.4	60	500	520	300	275	283	220	500	10	41.2
PI500-018G2	18.5	81.6	75	550	575	355	320	328	250	555	10	58
PI500-022G2	22	97.7	90	695	720	400	360	368	300	700	10	72.5
PI500-030G2	30	122.1	110	790	820	480	360	368	370	800	11	108
PI500-037G2	37	157.4	152	940	980	705	380	388	550	945	13	190
PI500-045G2	45	185.3	176	940	980	705	380	388	550	945	13	190
PI500-055G2	55	214	210	940	980	705	380	388	550	945	13	190
PI500-075G2	75	307	304	940	980	705	380	388	550	945	13	190
PI500-093G2	93	383	380	940	980	705	380	388	550	945	13	190
PI500-110G2	110	428	426	940	980	705	380	388	550	945	13	190
PI500-132G2	132	467	465	940	980	705	380	388	550	945	13	190
PI500-160G2	160	522	520	940	980	705	380	388	550	945	13	190

Inverter model	Output power (kW)	Input current (A)	Output current (A)	Dimension(H1xWxD1mm)					Installation (AxB dmm)			N.W (KG)
				H	H1	W	D	D1	A	B	d	
PI500-7R5G3/011F3	7.5/11	20.5/26	17/25	280	300	190	190	198	140	285	6	7.2
PI500-011G3/015F3	11/15	26/35	25/32	330	350	210	190	198	150	335	6	9.5
PI500-015G3/018F3	15/18.5	35/38.5	32/37	380	400	240	215	223	180	385	7	13
PI500-018G3/022F3	18.5/22	38.5/46.5	37/45	500	520	300	275	283	220	500	10	41.2
PI500-022G3/030F3	22/30	46.5/62	45/60	550	575	355	320	328	250	555	10	58
PI500-030G3/037F3	30/37	62/76	60/75	695	720	400	360	368	300	700	10	72.5
PI500-037G3/045F3	37/45	76/91	75/90	790	820	480	360	368	370	800	11	108
PI500-045G3/055F3	45/55	91/112	90/110	940	980	705	380	388	550	945	13	190
PI500-055G3/075F3	55/75	112/157	110/150	940	980	705	380	388	550	945	13	190
PI500-075G3	75	157	150	940	980	705	380	388	550	945	13	190
PI500-093F3	93	180	176	940	980	705	380	388	550	945	13	190
PI500-93G3/110F3	93/110	180/214	176/210	940	980	705	380	388	550	945	13	190
PI500-110G3/132F3	110/132	214/256	210/253	940	980	705	380	388	550	945	13	190
PI500-132G3/160F3	132/160	256/307	253/304	940	980	705	380	388	550	945	13	190
PI500-160G3/187F3	160/187	307/345	304/340	940	980	705	380	388	550	945	13	190
PI500-187G3/200F3	187/200	345/385	340/380	940	980	705	380	388	550	945	13	190
PI500-200G3/220F3	200/220	385/430	380/426	940	980	705	380	388	550	945	13	190
PI500-220G3	220	430	426	940	980	705	380	388	550	945	13	190
PI500-250F3	250	468	465	940	980	705	380	388	550	945	13	190
PI500-250G3/280F3	250/280	468/525	465/520	940	980	705	380	388	550	945	13	190
PI500-280G3/315F3	280/315	525/590	520/585	940	980	705	380	388	550	945	13	190
PI500-315G3/355F3	315/355	590/665	585/650	940	980	705	380	388	550	945	13	190
PI500-355G3/400F3	355/400	665/785	650/725	940	980	705	380	388	550	945	13	190
PI500-400G3	400	785	725	940	980	705	380	388	550	945	13	190
PI500-450F3	450	883	820	940	980	705	380	388	550	945	13	190
PI500-450G3/500F3	450/500	883/920	820/860	940	980	705	380	388	550	945	13	190
PI500-500G3/560F3	500/560	920/1010	860/950	940	980	705	380	388	550	945	13	190
PI500-560G3/630F3	560/630	1010/1160	950/1100	940	980	705	380	388	550	945	13	190
PI500-630G3/700F3	630/700	1160/1310	1100/1250	940	980	705	380	388	550	945	13	190
PI500-132G3R/160F3R	132/160	256/307	253/304	995	1020	400	360	368	350	270	13*18	114.5
PI500-160G3R/187F3R	160/187	307/345	304/340	995	1020	400	360	368	350	270	13*18	114.5
PI500-187G3R/200F3R	187/200	345/385	340/380	995	1020	400	360	368	350	270	13*18	114.5
PI500-200G3R/220F3R	200/220	385/430	380/426	995	1020	400	360	368	350	270	13*18	114.5
PI500-220G3R	220	430	426	995	1020	400	360	368	350	270	13*18	114.5
PI500-250F3R	250	468	465	995	1020	400	360	368	350	270	13*18	114.5
PI500-250G3R/280F3R	250/280	468/525	465/520	995	1020	400	360	368	350	270	13*18	114.5
PI500-280G3R/315F3R	280/315	525/590	520/585	995	1020	400	360	368	350	270	13*18	114.5
PI500-315G3R/355F3R	315/355	590/665	585/650	995	1020	400	360	368	350	270	13*18	114.5
PI500-355G3R/400F3R	355/400	665/785	650/725	995	1020	400	360	368	350	270	13*18	114.5
PI500-400G3R	400	785	725	995	1020	400	360	368	350	270	13*18	114.5

Remark: PI500 series frequency inverter PI500-132G3/PI500-160F3-PI500-400G3, "R" stands for "built-in DC choke", for example PI500-160G3R. After installing the screw rings, the height dimensions is :H1+15mm.

Standard specification

Item	Function	Specification	
Power	Rated voltage level	AC 3PH 380V(-15%)-440V(+10%)	
	Input frequency	50Hz/60Hz	
	Allowable fluctuation	Voltage continued volatility $\pm 10\%$ input frequency volatility: $\pm 5\%$ Voltage unbalance rate less than 3% Distortion meet IEC 61800-2 standard	
Control System	Control system	High performance vector control inverter based on DSP	
	Control method	V/F control, vector control W/O PG, vector control W/PG	
	Automatic torque boost function	Realize low frequency (1Hz) and large output torque control under the V/F control mode.	
	Acceleration/deceleration control	Straight or S-curve mode, Four times available and time range is 0.0 to 6500.0s.	
	V/F curve mode	Linear, square root/m-h power, custom V/F curve	
	Over load capability		G type: rated current 150% - 1 minute, rated current 180% - 2 seconds
			F type: rated current 120% - 1 minute, rated current 150% - 2 seconds
	Maximum frequency	Carrier Frequency	0.5 to 16kHz, automatically adjust carrier frequency according to the load characteristics.
		Input frequency resolution	Digital setting: 0.01Hz Analog setting: maximum frequency $\times 0.1\%$
		Start torque	G type: 0.5Hz/150% (vector control W/O PG) F type: 0.5Hz/100% (vector control W/O PG)
		Speed range	1:100 (vector control W/O PG) 1:1000 (vector control W/ PG)
		Steady-speed precision	Vector control W/O PG: $\leq \pm 0.5\%$ (rated synchronous speed) Vector control W/ PG: $\leq \pm 0.02\%$ (rated synchronous speed)
		Torque response	$\leq 40\text{ms}$ (vector control W/O PG)
		Torque boost	Automatic torque boost; manual torque boost (0.1% to 30.0%)
		DC braking	DC braking frequency: 0.0Hz to max. frequency, braking time: 0.0 to 36.0 seconds, braking current value: 0.0~100.0s
Jogging control		Jog Frequency Range: 0.00Hz to max. frequency; Jog Acc/deceleration time: 0.0s~6500.0s	
Multi-speed operation		Achieve up to 16-speed operation through the control terminal	
Built-in PID		Easy to realize closed-loop control system for the process control.	
Automatic voltage regulation(AVR)	Automatically maintain a constant output voltage when the voltage of electricity grid changes		
Torque limit and control	"Excavator" feature - torque is automatically limited during the operation to prevent frequent overcurrent trip; the closed-loop vector mode is used to control torque.		
Personalization function	Self-inspection of peripherals after power-on	After powering on, peripheral equipment will perform safety testing, such as ground, short circuit, etc.	
	Common DC bus function	Multiple inverters can use a common DC bus.	
	Quick current limiting	The current limiting algorithm is used to reduce the inverter overcurrent probability, and improve whole unit anti-interference capability.	
	Timing control	Timing control function: time setting range (0h to 6500m).	

Standard specification

Item	Function	Specification
Input signal	Running method	Keyboard/terminal/communication
	Frequency setting	10 frequency setting available, including adjustable DC 0-10V / -10~+10V, adjustable DC 0-20mA, panel potentiometer
	Start signal	Rotate forward/reverse
Output signal	Multi-speed	At most 16-speed can be set (run by using the multi-function terminals or program)
	Emergency stop	Interrupt controller output
	Wobulate run	Process control run
	Fault reset	When the protection function is active, you can automatically or manually reset the fault condition, including DC(0 to 10V), DC(0 to 20mA)
	PID feedback signal	
	Running status	Motor status display, stop, acc/deceleration, constant speed, program running status.
Run function	DC current braking	Contact capacity: normal-closed contact 3A/AC 250V; normal-opened contact 5A/AC 250V; 1A/DC 30V.
	Running command channel	Two-way analog output. 16 signals can be selected such as frequency, current, voltage and other, output signal range (0 to 10V, 0 to 20mA).
Protection function	Frequency source	At most 4-way output, there are 40 signals each way
	Input terminals	Limit frequency, jump frequency, frequency compensation, auto-tuning, PID control
	Output terminals	Built-in PID regulates braking current to ensure sufficient braking torque under no overcurrent condition. They can be switched through a variety of ways.
Display	LED/OLED display keyboard	Three channels: operation panel, control terminals and serial communication port. They can be switched through a variety of ways.
	LED display	Total 10 frequency sources: digital, analog voltage, analog current, multi-speed and serial port. They can be switched through a variety of ways.
	OLED display	8 digital input terminals, compatible with active PNP or NPN input mode, one of them can be for high-speed pulse input (0~100Hz square wave), 3 analog output terminals, AI1 and AI2 can choose 0-10V or 0-20mA input, AI3 voltage is -10~+10V input.
	Parameters copy	2 digital output terminals, one of them can be for high-speed pulse output (0 to 100kHz square wave); one relay output terminal; 2 analog output terminals respectively for optional range (0 to 20mA or 0 to 10V), they can be used to set frequency, output frequency, speed and other physical parameters.
Communication	Key lock and function selection	Overvoltage protection, undervoltage protection, overcurrent protection, overload protection, overheat protection, overcurrent stall protection, overvoltage stall protection, losing-phase protection (optional), external fault, communication error, PID feedback signal abnormalities, PG failure and short circuit to ground protection.
	RS485	Displays current temperature IGBT
Environment	Environment temperature	Can be set
	Storage temperature	Less than 15 milliseconds: continuous operation. More than 15 milliseconds: automatic detection of motor speed, instantaneous power-down restart.
	Environment humidity	The inverter automatically tracks motor speed after it starts
	Vibration	Protect inverter parameters by setting administrator Password and decoding
Product standard	Application sites	Monitoring objects including: running frequency, set frequency, actual motor current, DC bus voltage, output voltage, actual motor speed, cumulative running time, IGBT temperature, PID reference value, PID feedback value, input terminal status, output terminal status, analog AI1 value, analog AI2 value, current stage of multi-speed, torque set value.
	Pollution degree	At most save 3 error message, and the time, type, voltage, current, frequency and work status can be queried when the failure is occurred.
	IP degree	Display parameters
Product standard	Product adopts safety standards.	Optional, prompts operation content in Chinese/English text.
	Product adopts EMC standards.	Can uploading or downloading the function code information of frequency inverters, do the parameter copy quickly.
	Cooling method	Lock part or all of keys, define the function scope of some keys to prevent misuse.

Operating keyboard (button key description)



Sign	Name	Function
	Parameter Setting/ Exit Key	*Enter top menu parameter change status *Exit from function option change *Return to status display menu from sub-menu or function option menu
	Shift Key	*Select circularly parameters under run or stop interface; *Select parameters when modifying the parameters.
	Ascending Key	*UP key settled by parameter F6.18
	Decending Key	*DOWN key settled by parameter F6.19
	Run Key	*Used for running operation in the keyboard mode.
	Stop/Reset Key	*For stopping running in the running status; for resetting the operation in fault alarm status. *The function of the key is subject to F6.00
	Enter Key	*Enter into levels of menu screen, confirm settings.
	Quick multifunction key	*This key function is determined by the function code F6.21.
	Keyboard encoder	*In query status: functional items increasing and decreasing *In modify status: function feagues or editing increasing or decreasing *In monitoring status: setting frequency increasing or decreasing

Installation

Installation direction and Vacancy

PI500 series inverter according to different power rating, the requirements of around installation and reserved space is different, specifically as shown below:

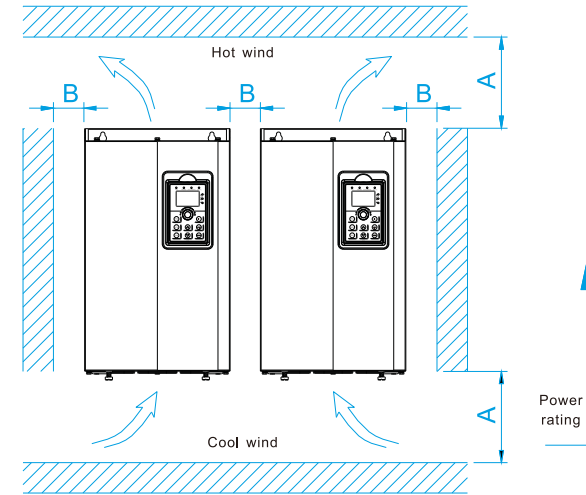

Mounted vertically upwards	Dimension requirement
7.5~22KW	A ≥ 200mm; B ≥ 10mm
30~75KW	A ≥ 200mm; B ≥ 50mm
93~400KW	A ≥ 300mm; B ≥ 50mm

PI500 Series frequency inverter heat radiator circulated from bottom to top, when more than one inverter work together, usually mounted side by side. In the case of the need to install them by upper and lower rows, due to the heat of the lower inverters rising to the upper equipment, fault may be caused, heat insulation deflector and other objects to be installed.

Use of the environment

1. Environmental temperature -10°C to 50°C Above 40°C, the capacity will decrease 3% by each 1°C. So it is not advisable to use inverter above 50°C
2. Prevent electromagnetic interference, and away from interference sources.
3. Prevent the ingress of droplets, vapor, dust, dirt, lint and metal fine powder.
4. Prevent the ingress of oil, salt and corrosive gases.
5. Avoid vibration. Maximum amplitude is less than 5.9m/s (0.6g).
6. Avoid high temperature and humidity or exposure to rain, humidity shall be less than 90% RH (non-condensing). In the presence of corrosive gas, maximum relative humidity is no more than 60%.
7. Altitude below 1000 meters.
8. Never use in the dangerous environment of flammable, combustible, explosive gas, liquid or solid.

Wiring

Frequency inverter wiring is divided by main circuit and control circuit. Users must properly connect frequency inverter in accordance with the wiring connection diagram showing below.

Wiring diagram

Peripheral equipment

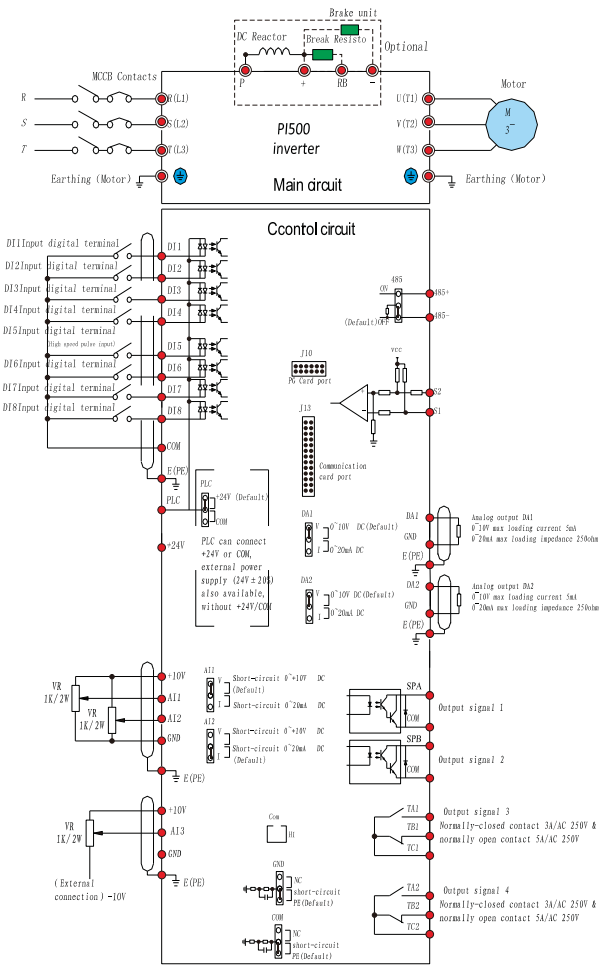

Purpose	Name	Specification
Protect frequency inverter wiring	Wiring breaker or leakage protector	To protect frequency inverter connection, please set wiring breaker or leakage protector by the side of power supply. Please use preventing ultra-harmonics leakage protector.
Prevent braking resistor burning-out	AC contactor	To prevent braking resistor burning-out when connecting, please set AC contactor, meanwhile, please connect surge absorber on the coil.
Preventing switching surge leaking out	Surge absorber	Surge absorber absorbing electromagnetic contactor and control relay switching surge, please install surge absorber on the electromagnetic contactor and control relay of frequency inverter.
Insulation input/output signal	Isolator	Due to frequency inverter insulation input/output signal, isolator can reduce inductive interference effectively
Improve frequency inverter input power factor	DC reactor/AC reactor	Apply to improve frequency inverter input power factor, please set DC reactor or AC reactor, when using large capacity power supply (above 600kW)
Reduce noise disturbance	Input noise filter	Input wiring can reduce noise flow into frequency inverter input power supply system, Please install the filter close to frequency inverter.
	Output noise filter	From frequency inverter output wiring reduce noise, please install the filter close to frequency inverter.
Machine stop running on setting time	Braking resistor	Braking unit will consume machine regenerated energy, which will reduce decrease time
	Braking unit	Braking unit and braking resistor combined using on machine, this will reduce motor decrease time.
Control frequency inverter operation from outside	Operator (small plastic -made device)	Control frequency setting and operation/stop operation by analog quantity instructions from distance.
	Operator (standard nickel clad made)	Control frequency setting and operation/stop operation by analog quantity instructions from distance.
Ensure frequency inverter sudden power failure compensation	Sudden power failure/compensate unit	To control power supply sudden failure compensation.
	Frequency meter	Outside setting and monitoring frequency device.
Frequency setting device knob		
Setting and monitoring frequency and voltage from outside	Frequency setting device knob	Outside setting output volt device is PWM frequency inverter specialized voltmeter.
	Output voltmeter	
Adjust frequency instruction input and frequency meter, ampere meter full scale	Frequency instruction using thyrector baseboard	Install and control circuit terminal, input frequency instruction.
	Frequency meter full scale adjust resistor	Adjust frequency meter and ampere meter full scale.

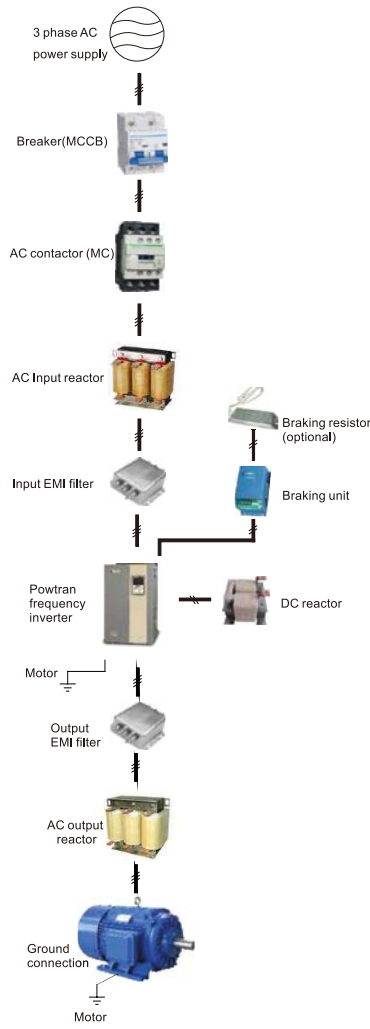

Some application cases



Coal Mining Industry

- engine analyzer, slag pot carrier, feeding machine, iron ladle motor, fireproof door, motor ore washing pump, suction fan in the pit, air supply system, hauling machine



Fan Industry

- centrifugal compressor, axial-flow compressor, centrifugal blower, roots blower, centrifugal fan, axial flow fan, fan blower

Machine Tool Industry

- electro-spindle, vertical lathe spindle, surface grinder spindle, boring machine spindle, sawing machine



Injection Molding Machine

- extruding machine, injection machine, die refiner, internal mixer, granulate machine



Pump

- petroleum pump, metallurgical pump, chemical pump, fishing pump, mining pump, power pump, water conservancy pump, sewage pump, food pump, brewing pump, pharmacy pump, beverage pump, fuel pump, condiment pump, paper pump, textile pump, printing and dyeing pump, ceramic pump, paint conveyer pump, agricultural chemical pump, fertilizer pump, sugar-syrup pump, methanol pump, spray pump, salt pump, beer pump, starch pump, feed pump



Winding Machine

- lithium battery winding machine, capacitor core winding machine, textile winding machine



Conveyor Belt

- belt-type conveyor, plate conveyor, car type conveyor, escalator, passenger conveyor, scraper conveyor, embedded scraper conveyor, bucket conveyor, bucket elevator, underslung conveyor, underslung conveyor



Heating System

- constant pressure water supply system for boiler, mill exhauster, belt conveyor for coal, coal breaker, air blower, induced draft fan, cold-rolling mill



Compressor

- piston compressor, screw compressor, centrifugal compressor, linear compressor



Photovoltaic

- microwave relay station, optical cable communication system, wireless paging station, satellite communication and satellite television receiving system, computerized telephone system in countryside, communication system in troops, railway and highway signalling system, lighthouse and beacon light, meteorological station, seismic station



Textile Industry

- spinning machine, fagoting machine, pounding machine, knitting machine, centrifugal dehydrator, spinning frame, aeration machine for print works, tentering and thermo-fixing machine, high temperature dyeing machine, decorating machine, bleaching machine, dyeing jiggers



Power Industry

- boiler blower, induced draft fan, boiler feeding pump, circulating water pump, low pressure drain pump, condensate pump, cooling water pump, mortar pump, coal feeder



Iron And Steel Industry

- winding engine for iron-smelting blast furnace, dust removing blower for blast furnace, air blower for blast furnace gas blanketing blowing engine, roots blower for digital thermometer, variable frequency exhaust fan for steel furnace roasting and purifying fan, hot rolling machine, cold tandem rolling mill, feeding system, mill exhauster, vibrating sieving machine, wire drawing machine, winding machine, blender mixer, drying machine, slime pump, draining pump, water supply pump, unbender, pipemaking machine, ladle crane motor



Chemical Industry

- vacuum kneader (agitator), dryer, film blowing machine, plastic mill, pulverizer, drafting device for short fiber, high speed spinning machine for chemical fiber, feedstock pump for oil refinery, pump for coking unit



Petroleum Industry

- plunger pump, beam pumping unit, oil transfer pump, gas transmission pipeline system compressor



Hoisting Industry

- mine hoist, mining electric locomotive port hoist, builders' lift, pile driver, large crane motor, tower crane lifting

